

# Product data sheet

## Specifications



Switch terminal , CE: 4-pole 100A ,  
UL: 4-pole 100A , IP20 , UL94 V-0

Model number: UK415

Order number: 5012.004

## Technical Parameters

---

CE: 4-pole 100A EN 60947-7-1

UL: 4-pole 100A UL 1059

---

Screw Torque: M8  $\leq$ 35.7Kgf.cm M5  $\leq$ 20.40Kgf.cm M4  $\leq$ 12.24Kgf.cm

---

Temperature Rise:  $\leq$ 45K

---

Dielectric Withstand Voltage: 3500V

---

Protection Class: IP20

---

Flame Retardant Rating: UL94 V-0

---

Safety Certifications: CE RoHS

UL: E334233-20250626

---

Rated Short-Time Withstand Current:  
Icw KA rms Is 4.5

---

Instantaneous Peak Current IPk KA: 20

---

Ui: UL: 500V

CE: 500V

---

# Materials

Dust Cover:	PC-V2
Body:	PA66-V0
Copper Bar:	H59 Brass, Nickel Plated
Screw:	Carbon steel, trivalent Rainbow Passivation, salt spray 48H







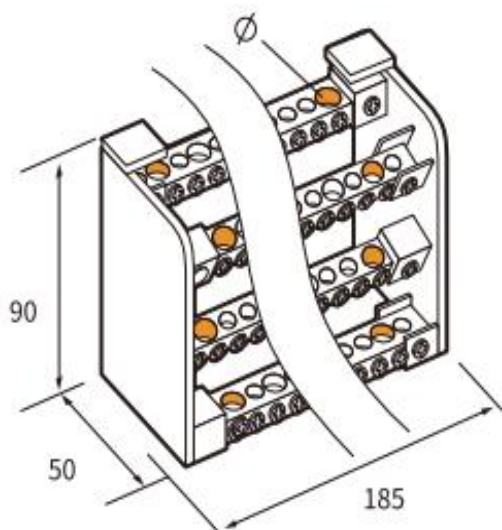

## Purpose Description

Key features include:

1. The mounting base is designed for standard NS35 rails, allowing direct installation on rails or base plates for quick and convenient assembly.
2. Separation of incoming and branching wires with staggered arrangement, making internal wiring more easily identifiable.
3. Compact design with multiple branching terminals, maximizing space savings for wiring.
4. Isolation barriers between every two poles to prevent short circuits caused by accidental wire contact.
5. Transparent dust cover design for insulation and electrical isolation, enabling clear visibility of internal wiring without opening the cover.

## Installation Instructions



	 mm <sup>2</sup>	 mm <sup>2</sup>	Digi	Ø		I(N.m)
	10...35	10...25	x1	8,5		2-3
	1,5...4	0.75...4	x10	4,5		1,2-1,5
	2,5...6	1,5...6	x3	5,5		2-3

# Product Drawings

LEIPOLE		EN 60947-7-1	
UK		-40°C	
415		Ipk 20kA	
⊖	Ø6.3	CE	UI: 600V In: 125A
⊖	1.5-8mm <sup>2</sup>	UI	UI: 600V In: 100A
⊖	2.5-8mm <sup>2</sup>	⊖	Ø7.5
		⊖	Ø9.5
		⊖	Ø9.5
		⊖	Ø25mm <sup>2</sup>
		⊖	10-25mm <sup>2</sup>
		⊖	10-35mm <sup>2</sup>

